

## LUXA SPHINX



Motion detector  
Presence detectors



Perfect Light Control

## PRODUCT OVERVIEW

### LUXA 101 series Motion detector

Motion detector in black or  
pure white

from page 8



for wall mounting



for wall mounting

### LUXA 102 series Motion detector

Motion detector with halogen spotlight  
in black or pure white

from page 16



for wall mounting



for wall mounting

### LUXA 103 series Motion detector

Motion detector in pure white

from page 20



for flush mounted  
ceiling installation



for surface mounted  
ceiling installation

### LUXA 103-200 series Motion detector

Flush-mounted motion detector in pure  
white

from page 28



for flush-mounted  
wall installation

### SPHINX 104 series Presence detector

Presence detector with highly sensitive  
sensor and large detection range  
With zero cross switching

from page 32



for flush mounted  
ceiling installation



for surface mounted  
ceiling installation

### SPHINX 105 series Motion detector











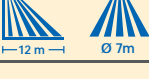
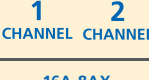

Motion detector for outdoor use.  
With zero cross switching

from page 36

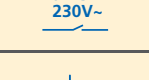



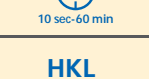
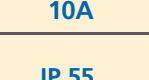

























































for surface-mounted  
wall installation

# SYMBOL KEY

	Wall mounted
	Ceiling mounted
	Wall installation in flush-mounted socket
	Ceiling mounting
	Detection angle
	Maximum detection range
	Channel 1: light output Channel 2: HVAC output only reacts to presence
	Maximum switching capacity with zero cross switching for resistive and capacitive loads (AX: $\cos \varphi = 0.3$ /fluorescent lamps)
	Maximum switching capacity for resistive and capacitive loads (AX: $\cos \varphi = 0.3$ /fluorescent lamps)
	Maximum switching capacity for incandescent and halogen lamp loads
	Adjustable lux value for switching on lighting when presence is detected
	Adjustable switching period according to last detected movement
	HVAC switching period according to last detected movement
	"Presence HVAC" (heating, ventilation, air conditioning) switching output only reacts to presence. Max. switching current (230 V)
	Display of protection rating subject to designated installation
	Optional service and user remote control, e.g. with teach in function for desired switching brightness (teach-in)

# Model comparison

LUXA	Wall mounted	Ceiling mounted	Detection angle	Detection range	Channels	Switching capacity	Lamp load max.	Switching brightness	Switching period	HVAC switching capacity	HVAC switching period	Protection rating	Remote control	Order number	Page number
<b>LUXA 101</b> Wall or ceiling motion detectors															
LUXA 101-150					1 CHANNEL	10A-3AX 230V~	1000 W	5-1000 Lux	5 sec-12 min			IP 55		101 0 963	8-11
LUXA 101-150					1 CHANNEL	10A-3AX 230V~	1000 W	5-1000 Lux	5 sec-12 min			IP 55		101 0 964	8-11
LUXA 101-180					1 CHANNEL	10A-3AX 230V~	1000 W	5-1000 Lux	5 sec-12 min			IP 55		101 0 961	8-11
LUXA 101-180					1 CHANNEL	10A-3AX 230V~	1000 W	5-1000 Lux	5 sec-12 min			IP 55		101 0 962	8-11
LUXA 101-360					1 CHANNEL	10A-3AX 230V~	1000 W	5-1000 Lux	5 sec-12 min			IP 55		101 0 460	12-15
<b>LUXA 102</b> Motion detector with halogen spotlights															
LUXA 102-150/150W					1 CHANNEL		150W 230V	5-1000 Lux	5 sec-12 min			IP 55		102 0 961	16-19
LUXA 102-150/150W					1 CHANNEL		150W 230V	5-1000 Lux	5 sec-12 min			IP 55		102 0 962	16-19
LUXA 102-150/500W					1 CHANNEL		500W 230V	5-1000 Lux	5 sec-12 min			IP 55		102 0 963	16-19
LUXA 102-150/500W					1 CHANNEL		500W 230V	5-1000 Lux	5 sec-12 min			IP 55		102 0 964	16-19
<b>LUXA 103</b> Ceiling mounted motion detector															
LUXA 103-360					1 CHANNEL	10A-3AX 230V~	1000 W	10-2000 Lux	1 sec-20 min			IP 40		103 0 010	20-23
LUXA 103-360/2					2 CHANNEL	10A-3AX 230V~	1000 W	10-2000 Lux	time 1 1 sec-20 min	HKL 10A	time 2 10 sec-60 min	IP 40		103 0 011	20-23
LUXA 103-360 AP					1 CHANNEL	10A-3AX 230V~	1000 W	10-2000 Lux	1 sec-20 min			IP 40		103 0 020	24-27
LUXA 103-360/2 AP					2 CHANNEL	10A-3AX 230V~	1000 W	10-2000 Lux	time 1 1 sec-20 min	HKL 5A	time 2 10 sec-60 min	IP 40		103 0 021	24-27
<b>LUXA 103-200</b> Flush mounted motion detector															
LUXA 103-200					1 CHANNEL	10A-3AX 230V~	1000 W	10-2000 Lux	20 sec-30 min			IP 40		103 0 030	28-31
LUXA 103-200 T					1 CHANNEL	Triac 2A 230V	25-400 W	10-2000 Lux	20 sec-30 min			IP 40		103 0 031	28-31

# Model comparison

SPHINX	Wall mounted	Ceiling mounted	Detection angle	Detection range	Channels	Switching capacity Zero point switching	Lamp load max.	Brightness range	Switching period	HVAC switching capacity	HVAC switching period	Protection rating	Remote control	Order number	Page number
<b>SPHINX 104</b> Ceiling mounted presence detectors															
SPHINX 104-360					1 CHANNEL	8A-8AX 230V~	1800 W	10-2000 Lux	1 sec-20 min			IP 41		104 0 370	P. 32-35
SPHINX 104-360/2					2 CHANNEL	8A-8AX 230V~	1800 W	10-2000 Lux	time 1 1 sec-20 min	HKL 3A	time 2 10 sec-60 min	IP 41		104 0 372	P. 32-35
SPHINX 104-360 AP					1 CHANNEL	16A-8AX 230V~	2000 W	10-2000 Lux	1 sec-20 min			IP 41		104 0 360	P. 32-35
SPHINX 104-360/2 AP					2 CHANNEL	16A-8AX 230V~	2000 W	10-2000 Lux	time 1 1 sec-20 min	HKL 5A	time 2 10 sec-60 min	IP 41		104 0 362	P. 32-35
<b>SPHINX 105</b> Wall- and ceiling-mounted motion detectors															
SPHINX 105-110					1 CHANNEL	16A-8AX 230V~	2300 W	2-2000 Lux	5 sec-20 min			IP 55		105 0 110	P. 36-39
SPHINX 105-220					1 CHANNEL	16A-8AX 230V~	2300 W	2-2000 Lux	5 sec-20 min			IP 55		105 0 220	P. 36-39
SPHINX 105-300					1 CHANNEL	16A-8AX 230V~	2300 W	2-2000 Lux	5 sec-20 min			IP 55		105 0 300	P. 36-39
<b>Accessories for motion and presence detectors</b>															
RC-filter (250 V AC / 47 Ω, 0,1 μF), dimensions: 24 x 13 x 6 mm														907 0 523	

**thebenHTS®**

## Presence detectors

can be found in the ThebenHTS brochure

Presence light range



Compact range



ECO-IR range







Save energy with Theben. Presence and motion

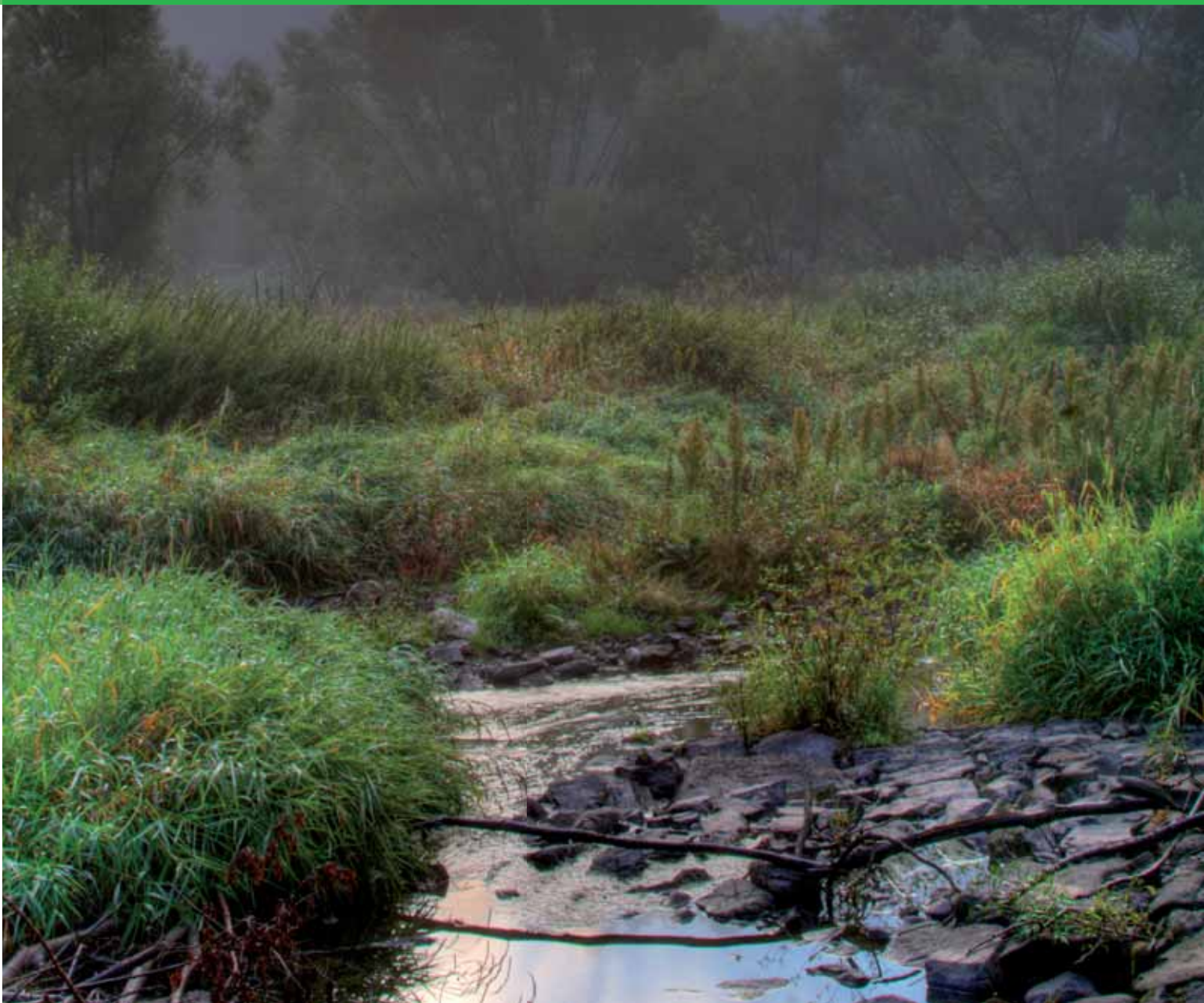



Dear clients and partners,

Reducing CO<sub>2</sub>,  
Protecting the climate,  
Saving energy costs.

In this catalogue, under the Motto "Energy saving ideas", you will find beneficial ideas and solutions: intelligent systems for efficiently controlling time, light, and climate from Theben. So you can live better.

Look forward to the future with Theben.

A handwritten signature in white ink that reads "Thomas Goes". The signature is fluid and cursive, with the first letter 'T' being particularly large and stylized.

Thomas Goes  
Chairman of the Board

# The complete range for energy efficient lighting control

## Premium

- The designer solution for modern private and functional buildings
- Optimum planning through almost square detection areas
- Excellent reliability; therefore, particularly suitable for large offices, schools, sports halls, public buildings
- 1 or 2 channels
- Constant 24 V lighting
- KNX presence detectors



Please ask for Theben HTS catalogue.

## Comfort

- Easy to operate via remote control
- Large radial detection area
- External wall installation for yard, drive and outside area lighting
- Internal installation for offices, sales rooms, sanitary facilities
- 1 or 2 channels



Page 28 – 35

## Standard

- Motion detectors for new build and renovation projects
- Suitable for residential and functional buildings
- Property monitoring via devices with and without halogen spotlights
- 1 or 2 channels



Page 8 – 23



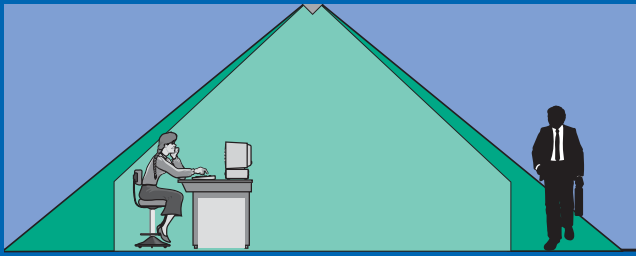

Ceiling mounted presence detectors provide a constantly high detection sensitivity. They are particularly suitable for people in seated positions.

## thebenHTS Internal presence detectors for wall or ceiling installation

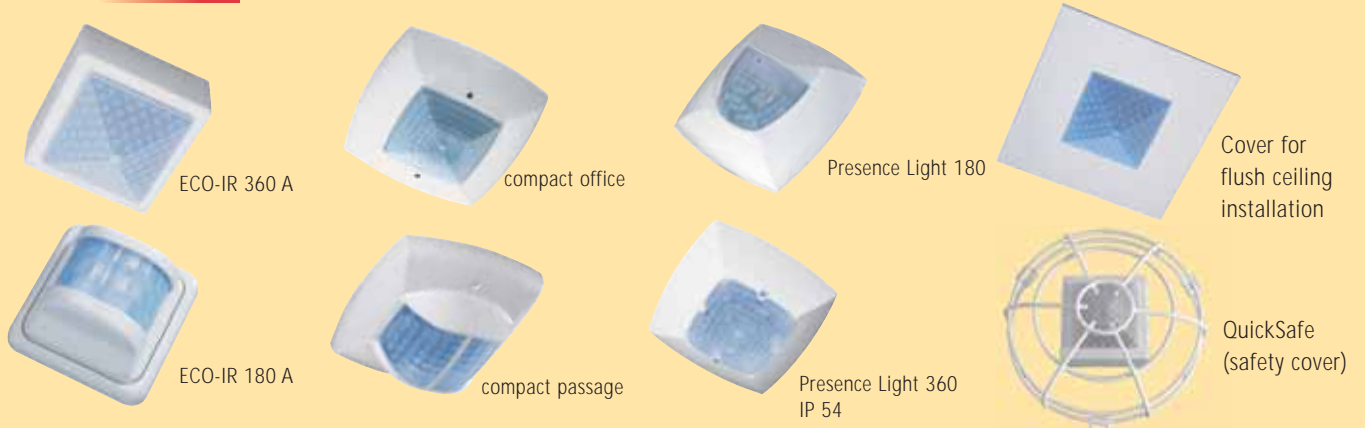

## SPHINX: Internal and external presence and motion detectors for universal installation



## LUXA: Internal and external motion detectors for wall, ceiling and flush-mounted installation



LUXA 101 motion detector  
for wall installation

# Eagle eyes bring everything into view

LUXA 101-180

The LUXA 101 is particularly  
suitable for fitting to walls

Attractive housing  
in white or black

Rotating and tilting  
sensor head with  
ball joint

Highly sensitive  
sensor

Plug-in base for quick and  
easy installation

Additional  
creep under protection, ideal  
for installation above doors







Bright entrance lighting, that switches on automatically when the entrance area or customer parking spaces are occupied, provides customers and guests with a warm welcome. Demand-dependent control ensures low energy costs and a high level of comfort.

The LUXA 101-150 and LUXA 101-180 motion detectors are suitable for automatic external and internal lighting. The ball joint fitting makes it easy to set the detection area.



The LUXA 101-150 and LUXA 101-180 models are available in black or white.



Easy installation through fully adjustable detection area with 180° rotation and 0 – 40° tilting sensor head.



Setting at the back of the ball head via 3 potentiometers for brightness threshold (lux), lighting period (time) and detection range (metres).



Creep under protection with 360° detection area ensures that entrances are lit up as soon as you leave the property.



The integrated plug-in base enables quick and secure connection. Cable guide with rubber grommets from underneath or at the back of the device.



Optional corner adapter for monitoring corner seats outside or for monitoring corners of the property.

# LUXA 101 motion detector for wall installation



LUXA 101-150 (white)



LUXA 101-180 (black)



LUXA corner installation bracket (optional)

LUXA 101-150 detection area:  
Installation height 2.5 m

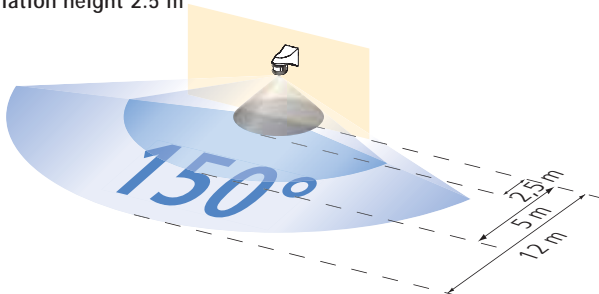

LUXA 101-180 detection area:  
Installation height 2.5 m

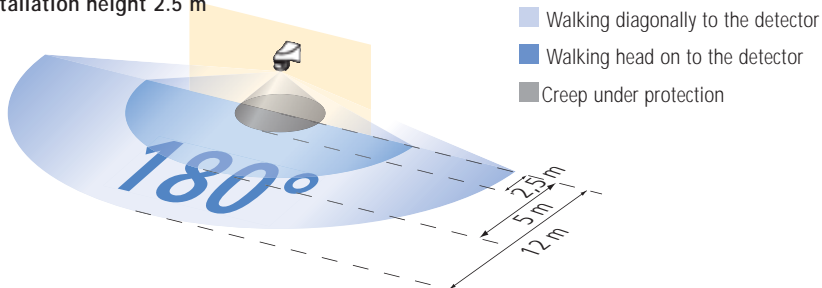

## Function

- Passive infrared motion detector for internal and external wall installation
- Corner wall installation with optional corner installation bracket for internal and external corners
- Automatic lighting control based on presence and brightness
- Large detection area with a maximum 12 m radius
- Sensor send can be rotated horizontally by  $\pm 90^\circ$  and tilted downwards by  $40^\circ$ , thus allowing maximum adjustability
- Additional creep under protection to cover a  $360^\circ$  area with a maximum diameter of 5 m at installation height of 2.5 m
- Lighting control with adjustable light threshold value and adjustable run-on time
- Controls installed with protection
- Blended light measurement suitable for the control of fluorescent, incandescent and halogen lamps
- Light switch output (relay 230 V~), floating
- Instant start-up possible via factory preset
- Single handed plug-in installation with captive screws
- Housing available in pure white or black
- Sensitivity can be reduced to limit detection area

## LUXA 101-150 motion detector

- 150° horizontal detection area

## LUXA 101-180 motion detector

- 180° horizontal detection area

## Connection diagrams:

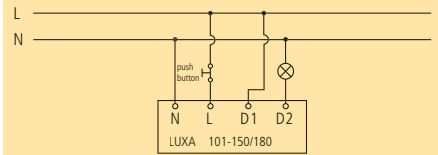

LUXA 101-150, LUXA 101-180 with optional manual switch

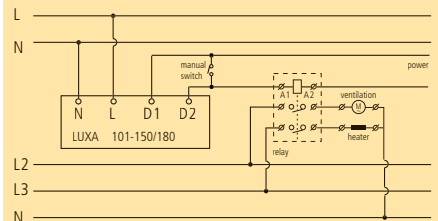

LUXA 101-150, LUXA 101-180 at various phases, e.g. for HVAC



Technical data:	LUXA 101-150	LUXA 101-180
Operating voltage	230 V~ +10%/-15%	230 V~ +10%/-15%
Frequency	50-60 Hz	50-60 Hz
Brightness range	5-1000 lux (infinitely variable)	5-1000 lux (infinitely variable)
Power consumption	typically 8 VA	typically 8 VA
Channels	1	1
Contact	NO contact ( $\mu$ )	NO contact ( $\mu$ )
Switching capacity ( $\cos \varphi = 1$ resistive load)	10 A	10 A
Switching load ( $\cos \varphi = 0.6$ motor load)	6 A	6 A
Switching capacity ( $\cos \varphi = 0.3$ fluorescent lamp)	3 AX	3 AX
Incandescent lamp load	1000 W	1000 W
Halogen lamp load	1000 W	1000 W
Fluorescent lamps (VVG) uncorrected ①	900 VA (100 $\mu$ F)	900 VA (100 $\mu$ F)
Fluorescent lamps (VVG) series-connected ①	900 VA	900 VA
Fluorescent lamps (VVG) parallel-connected ①	200 VA (18 $\mu$ F)	200 VA (18 $\mu$ F)
Fluorescent lamp load (VVG) (lead-lag circuit) ①	400 VA	400 VA
Fluorescent lamps (EVG) ②	400 VA	400 VA
Detection angle	150°	180°
Detection range, installation height 2.5 m	3-12 m (infinitely variable)	3-12 m (infinitely variable)
Creep under protection	$\varnothing$ 5 m	$\varnothing$ 5 m
Switching period range	5 s-12 min (infinitely variable)	5 s-12 min (infinitely variable)
Protection rating in accordance with EN 60529	IP 55	IP 55
Protection class in accordance with EN 60669-2-1	II, subject to correct installation	II, subject to correct installation
Operating temperature range	-15 °C to + 45 °C	-15 °C to + 45 °C
Installation type	Wall mounted, internal corner and external corner	Wall mounted, internal corner and external corner
Device order number pure white (incl. screws and rawplugs)	101 0 963	101 0 961
Device order number black (incl. screws and rawplugs)	101 0 964	101 0 962
Accessories:		
Pure white corner installation bracket	907 0 626	907 0 626
Black corner installation bracket	907 0 625	907 0 625

① Conventional ballast, ② Electronic ballast

#### Dimension diagrams (mm):

LUXA 101-150/LUXA 101-180

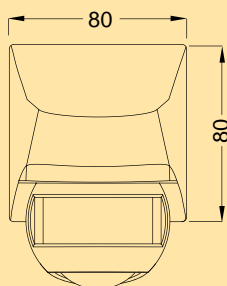
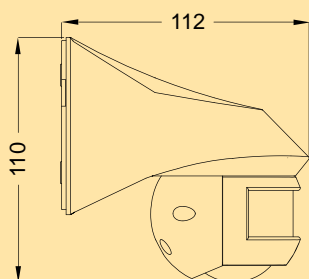

LUXA corner installation bracket

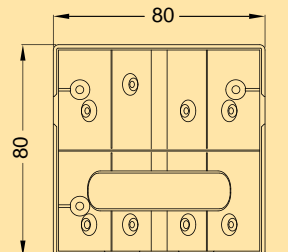

LUXA 101 motion detector  
for wall or ceiling installation

# Everyone can be seen.

LUXA 101-360

Swivel sensor head for wall and ceiling installation

Attractive housing in white

Highly sensitive sensor with extremely long potential range of a 5 to 16 m radius

Plug-in base for easy installation is included in delivery complete with screws and rawplugs







All four sides of the building should be monitored to provide all round coverage. That is no problem as two LUXA 101-360 motion detectors mounted on two corners of the building can monitor all the doors and windows. The corner installation bracket is ideal for mounting the devices on corners of buildings.

LUXA 101-360 motion detectors are suitable for monitoring large areas both externally and internally for automatic lighting control. Just two devices can monitor buildings up to 16 x 16 m.



The LUXA 101-360 has an adjustable base which makes it suitable for ceiling installation in large rooms up to a maximum area of 22 x 22 m.



Setting on the bottom of the sensor via 3 potentiometers for brightness threshold (lux), lighting period (time) and detection range (metres).



The integrated plug-in base with screwless terminals enables quick and secure connection. Cable guide with rubber grommets can be fitted from below or at the back of the device.



Corner installation allows two facades to be monitored by one device. This makes monitoring buildings more cost effective as only two devices are usually needed to monitor the whole perimeter of the building.



Optional corner adapter for monitoring corner seats outside.



Segments can be inserted to limit the detection range in order to avoid to prevent the device being switched on unnecessarily.

# LUXA 101 motion detector for wall or ceiling installation



LUXA 101-360



LUXA corner installation bracket

## LUXA 101-360 motion detector

- Passive infrared motion detector for wall and ceiling installation
- Internal or external installation possible using optional corner installation bracket
- Automatic lighting control based on presence and brightness
- Large detection area with a maximum 32 m diameter
- Sensor head can be adjusted vertically by 90° upwards or 70° downwards, thus allowing universal installation
- Additional creep under protection to cover a 360° area with a diameter of 5 m at installation height of 2.5 m
- Detection range can be limited using enclosed segments. This avoids switching the device on unnecessarily
- Blended light measurement suitable for the control of fluorescent, incandescent and halogen lamps
- Light switch output (relay 230 V~), floating
- Instant start-up possible via factory preset
- Lighting control with adjustable light threshold value and adjustable run-on time
- Screwless terminals for quick installation
- Single-handed plug-in installation with captive screws
- Sensitivity can be reduced to limit detection area

## Connection diagrams:

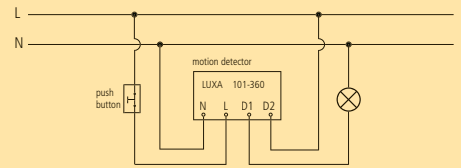

LUXA 101-360 with optional manual switch

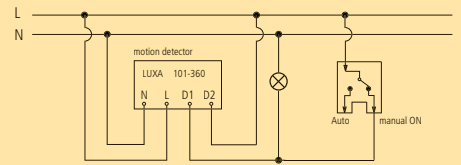

LUXA 101-360 with optional changeover switch

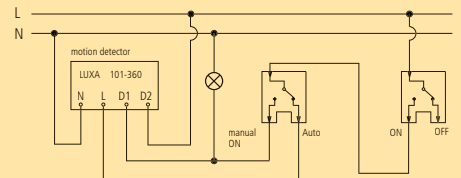

LUXA 101-360 with two optional changeover switches

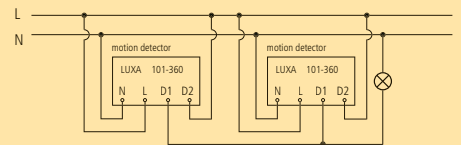

2 LUXA 101-360s control one load

LUXA 101-360 detection area:  
Installation height 2.5 m

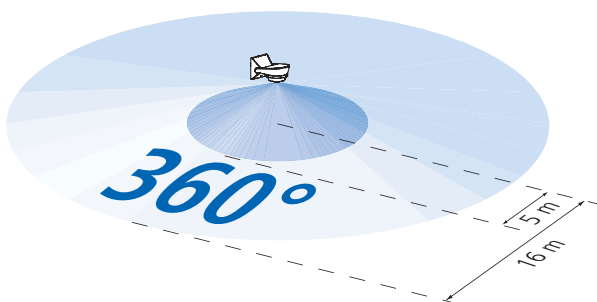

- Walking diagonally to the detector
- Walking head on to the detector

Technical data:	LUXA 101-360
Operating voltage	230 V~ +10 % / -15 %
Frequency	50–60 Hz
Brightness range	5–1000 lux (infinitely adjustable)
Power consumption	typically 8 VA
Channels	1
Contact	NO contact (μ)
Switching capacity (cos φ = 1 resistive load)	10 A
Switching load (cos φ = 0.6 motor load)	6 A
Switching capacity (cos φ = 0.3 fluorescent lamp)	3 AX
Incandescent lamp load	1000 W
Halogen lamp load	1000 W
Fluorescent lamps (VVG) uncorrected ①	900 VA
Fluorescent lamps (VVG) series-connected ①	900 VA
Fluorescent lamps (VVG) parallel-connected ①	200 VA (18 μF)
Fluorescent lamp load (VVG) (lead-lag circuit) ①	400 VA
Fluorescent lamps (EVG) ②	400 VA
Detection angle	360°
Detection range, installation height 2.5 m	Ø 6 m–Ø 32 m (infinitely variable)
Switching period range	5 s–12 min (infinitely variable)
Protection rating in accordance with EN 60529	IP 55
Protection class	II, subject to correct installation
Operating temperature range	-15 °C to + 45 °C
Installation type	Wall and ceiling mounted, internal corner and external corner installation
Device order number	<b>101 0 460</b>
Accessories:	
White corner installation bracket	907 0 626

① Conventional ballast, ② Electronic ballast

#### Dimension diagrams (mm):

LUXA 101-360

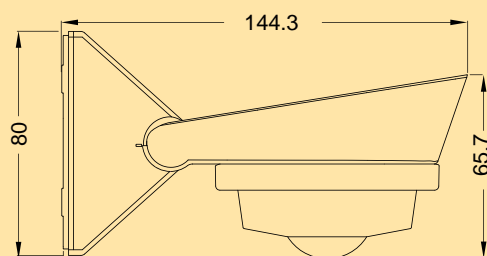
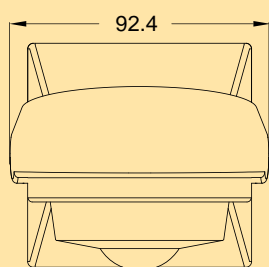

LUXA corner installation bracket

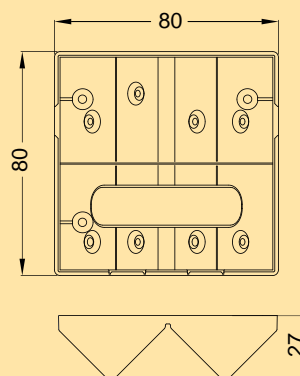

Motion detector with halogen spotlights LUXA 102  
for wall installation

# For lighting courtyard entrances and properties

LUXA 102-150/150W or  
LUXA 102-150/500W

Attractive housing  
in white or black

Integrated 500 W  
halogen spotlight can be  
rotated and swivelled

Ideal for fitting  
on walls.



Version with 500 W spotlight

Plug-in installation for  
quick and easy instal-  
lation

Rotating and tilting sensor head  
with ball joint

Highly sensitive sensor with  
additional creep under protection,  
ideal for mounting above doors



Version with 150 W spotlight

LUXA





If you need security in every last corner: Nothing gets past the LUXA motion detector. Anyone who enters the property is detected and the lighting is triggered.

The LUXA 102-150/150W and LUXA 102-150/500W motion detectors are ideal for security lighting all round the house or on company sites. The ball joint fitting extends installation options and provides for the optimum setting of detection ranges.



LUXA 102-150/150W and LUXA 102-150/500W are both available with black or white housing.



Easy installation through fully adjustable detection area with 180° rotation and 0 – 40° tilting sensor.



Setting at the back of the ball head via 3 potentiometers for brightness threshold (lux), lighting period (time) and detection range (metres).



Creep under protection via a downward facing 360° detection area ensures that entrances are lit up immediately.



The integrated plug-in base also provides and quick and secure connection for additional parallel switched lighting. Cable guide with rubber grommets from underneath or at the back of the device.



The high power halogen spotlights with integrated reflectors are easy to adjust: 45° laterally, 60° upwards and 30° downwards.

# Motion detector with halogen spotlights LUXA 102 for wall installation



LUXA 102-150/150W, white



LUXA 102-150/500W, black

## Function

- Passive infrared motion detector for internal and external wall installation
- Integrated 150 W or 500 W halogen spotlight for extensive lighting
- Spotlight can be swivelled  $\pm 45^\circ$  horizontally, and adjusted  $60^\circ$  upwards and  $30^\circ$  downwards using screw fixings
- Spotlight with tough aluminium die cast housing
- Switching output for additional light sources
- Automatic lighting control based on presence and brightness
- $150^\circ$  horizontal detection area
- Large detection area with a maximum 12 m radius
- Sensor send can be rotated horizontally by  $\pm 90^\circ$  and tilted downwards by  $40^\circ$ , thus allowing maximum adjustability
- Additional creep under protection to cover a  $360^\circ$  area with a maximum diameter of 5 m at installation height of 2.5 m
- Lighting control with adjustable light threshold value and adjustable run-on time
- Controls installed with protection
- Blended light measurement suitable for the control of fluorescent, incandescent and halogen lamps
- Additional light switch output (relay 230 V-)
- Instant start-up possible via factory preset
- Single-handed plug-in installation with captive screws
- Housing available in pure white or black
- Sensitivity can be reduced to limit detection area

## LUXA 102-150/150W motion detector

- with 150 W halogen searchlight

## LUXA 102-150/500W motion detector

- with 500 W halogen searchlight

## Connection diagrams:

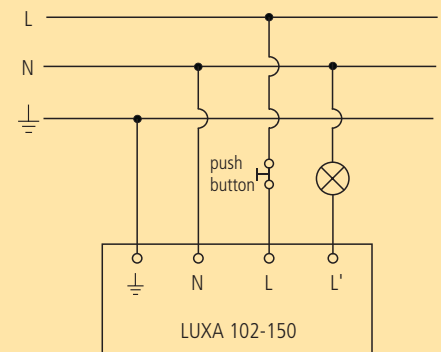

LUXA 102 with optional manual switch

## LUXA 102-150 detection area Installation height 2.5 m

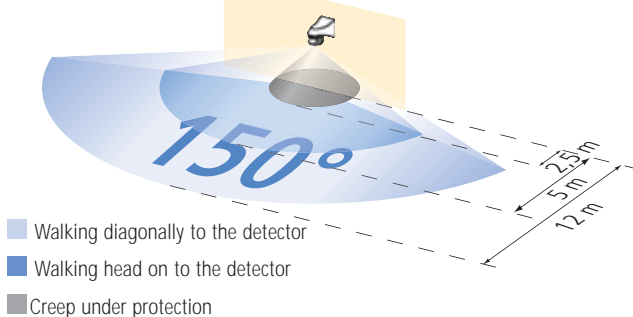

Technical data:	LUXA 102-150/150W	LUXA 102-150/500W
Operating voltage	230 V~ +10%/-15%	230 V~ +10%/-15%
Frequency	50-60 Hz	50-60 Hz
Brightness range	5-1000 lux (infinitely variable)	5-1000 lux (infinitely variable)
Power consumption	typically 8 VA	typically 8 VA
Channels	1	1
Contact	NO contact ( $\mu$ )	NO contact ( $\mu$ )
Switching capacity ( $\cos \varphi = 1$ resistive load)	8 A	8 A
Switching load ( $\cos \varphi = 0.6$ motor load)	6 A	6 A
Switching capacity ( $\cos \varphi = 0.3$ fluorescent lamp)	3 AX	3 AX
additional incandescent lamp load	500 W	500 W
additional halogen lamp load	500 W	500 W
Fluorescent lamps (EVG) ②	400 VA	400 VA
Detection angle	150°	150°
Detection range 2.5 m, installation height	3-12 m (infinitely variable)	3-12 m (infinitely variable)
Creep under protection	$\varnothing$ 5 m	$\varnothing$ 5 m
Switching period range	5 s-12 min (infinitely variable)	5 s-12 min (infinitely variable)
Halogen spotlight setting	45° laterally, 60° upwards, 30° downwards	45° laterally, 60° upwards, 30° downwards
Halogen spotlight incl. bulb	150 W	500 W
Protection rating in accordance with EN 60529	IP 55	IP 55
Protection class in accordance with EN 60669-2-1	I, subject to correct installation	I, subject to correct installation
Operating temperature range	-15 °C to + 45 °C	-15 °C to + 45 °C
Installation type	Wall mounted, internal corner and external corner	Wall mounted, internal corner and external corner
Device order number white (incl. screws and rawplugs)	102 0 961	102 0 963
Device order number black (incl. screws and rawplugs)	102 0 962	102 0 964
Accessories:		
White corner installation bracket	907 0 626	907 0 626
Black corner installation bracket	907 0 625	907 0 625

② Electronic ballast

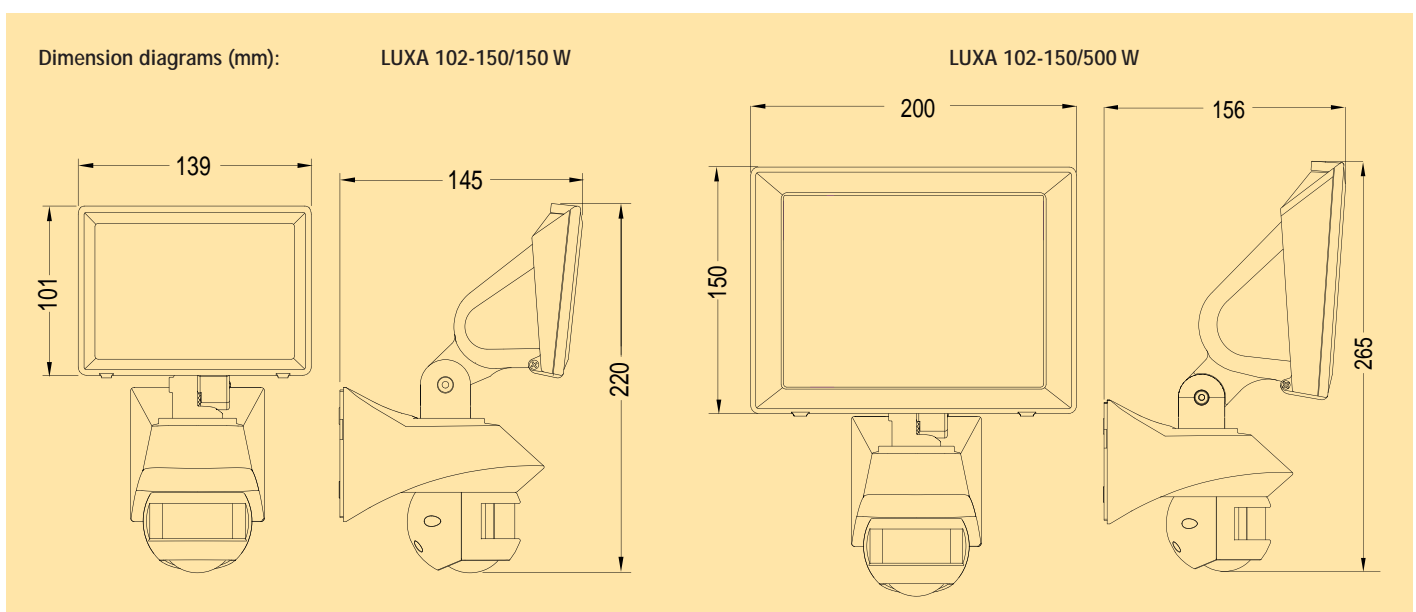

LUXA 103 motion detector  
for flush-mounted ceiling installation

# Inconspicuous room monitoring from ceiling.

LUXA 103-360

Reliable spring clamping bracket fitting

Flush fitting, round cover in white

All settings on the retractable sensor are protected against unauthorised use

The two channel version also allows control of heating, ventilation and air conditioning



Power box in separate housing with plug connectors to sensor





LUXA 103-360/2 controls more than one light if it gets dark; it also controls air conditioning when presence is detected, provides a pleasant room temperature and saves energy when room is unoccupied and at weekends.

LUXA 103-360 motion detectors are suitable for monitoring large internal areas for automatic lighting control.



LUXA 103-360 with one channel. Setting under the cover of the sensor via 3 potentiometers for brightness (lux), lighting period (time) and detection range (metres).



The power box with power unit and relay is connected to the sensor with a connecting lead with plug-in connection.



Sensor is securely fixed to ceiling with two spring terminals. Drill diameter 65 – 68 mm, wall thickness up to 25 mm.



LUXA 103-360/2 with two channels. Setting under the cover of the sensor via 4 potentiometers for brightness threshold (lux), lighting period (time) and detection range (metres).



The 2-channel power box with power unit and 2 relays are connected to the sensor with a connecting lead (30 cm) with plug-in connection. The second channel only reacts to presence, independent of brightness level.



Separate power box with plug-in connection to the sensor allows the device to be installed during preliminary building works or later by insertion through cut out in ceiling Ø 65 mm.

# LUXA 103 motion detector for flush-mounted ceiling installation



LUXA 103-360



LUXA 103-360/2

## LUXA 103-360 motion detector

- Small, inconspicuous passive infrared motion detector for ceiling installation
- Automatic lighting control based on presence and brightness
- Large detection area with a maximum 7 m diameter at installation height of 2.5 m
- Sensor head can be adjusted downwards by 45° in 15° stages thus allowing detection area to be changed to avoid switching the device on unnecessarily
- Blended light measurement suitable for the control of fluorescent, incandescent and halogen lamps
- Instant start-up possible via factory preset
- Lighting control with adjustable light threshold value and adjustable run-on time
- Sensitivity can be reduced to limit detection area
- Ceiling cut out of 65–68 mm diameter
- Device for cutting out suspended ceilings, protection rating IP 40
- Easy attachment via two clamping brackets
- System consists of power box and sensor with connecting lead
- Sensor can easily be removed during decoration work and replaced afterwards
- No unintentional adjustment due to covered up controls
- Screw terminals and large terminal area for quick installation
- Additional pulse control can be selected for combination with staircase time switches (ELPA), building automation or SPS

## LUXA 103-360/2 motion detector

- As before but two channel version
- Second relay for HVAC control, presence dependent, floating
- HVAC control with programmable run-on time

## Connection diagrams:

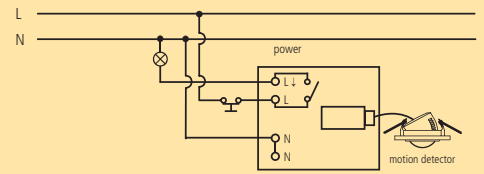

LUXA 103-360 with optional manual switch

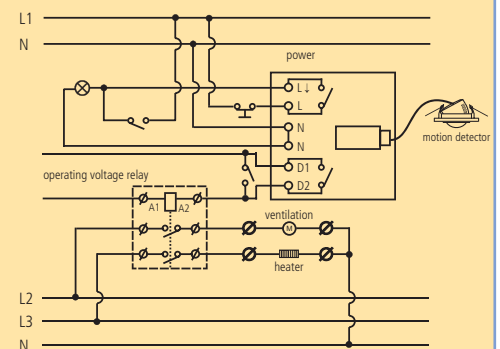

LUXA 103-360/2 with optional manual switches and heating or ventilation control depending on the time of the year

## LUXA 103-360 detection area Installation height 2.5 m

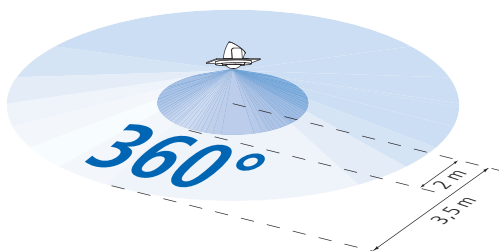

- Walking diagonally to the detector
- Walking head on to the detector



Technical data:	LUXA 103-360	LUXA 103-360/2
Operating voltage	230 V~ +10%/-15%	230 V~ +10%/-15%
Frequency	50-60 Hz	50-60 Hz
Brightness range	10-2000 Lux	10-2000 Lux
Power consumption	typically 8 VA	typically 12 VA
Channels	1	2
Contact	NO contact ( $\mu$ )	NO contact ( $\mu$ )
Switching capacity ( $\cos \varphi = 1$ resistive load)	10 A	10 A
Switching capacity ( $\cos \varphi = 0.3$ fluorescent lamp)	3 AX	3 AX
Incandescent lamp load	1000 W	1000 W
Halogen lamp load	1000 W	1000 W
Fluorescent lamps (VVG) corrected ①	400 VA (42 $\mu$ F)	400 VA (42 $\mu$ F)
Presence contact, floating (HKL, D1-D2)		5 A ( $\cos \varphi = 1$ ), 250 V AC or 24 V DC
Detection range 2.5 m installation height	360° circular	360° circular
moving persons	approx. $\varnothing$ 4-7 m (infinitely variable)	approx. $\varnothing$ 4-7 m (infinitely variable)
Installation height	2.0-3.0 m	2.0-3.0 m
Brightness setting range (lux)	10-2000 (infinitely variable)	10-2000 (infinitely variable)
Light channel switching period	Pulse (1 s)/TEST (2 s)/5 s-20 min	pulse (1 s)/TEST (2 s)/5 s-20 min
Presence channel switching period (HVAC)		10 s/15 min/30 min/60 min (infinitely variable)
Protection rating in accordance with EN 60529	sensor IP 40, power unit IP 20	sensor IP 40, power unit IP 20
Protection class in accordance with EN 60669-2-1	II, subject to correct installation	II, subject to correct installation
Operating temperature range	0 °C to + 45 °C	0 °C to + 45 °C
Installation type	Ceiling mounted	Ceiling mounted
Device order number	<b>103 0 010</b>	<b>103 0 011</b>

① Conventional ballast

Dimension diagrams (mm):

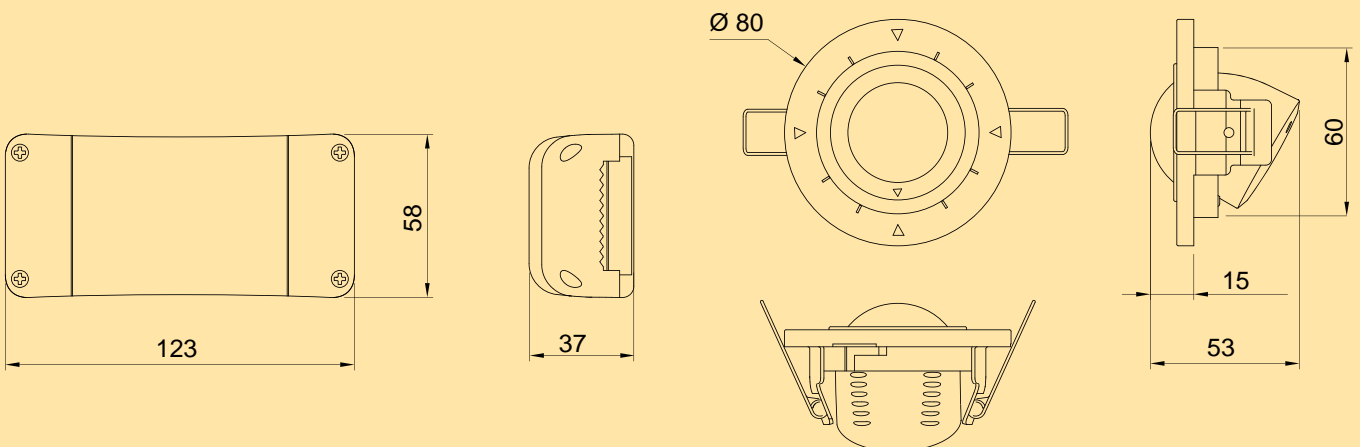

LUXA 103 motion detector  
for surface-mounted ceiling installation

# Energy saving lighting control is easy to add-on

LUXA 103-360 AP

LUXA 103-360 AP  
for ceiling installation

Attractive, round housing in white  
without visible fixing screws

All controls are completely  
covered to prevent  
unauthorised access



The sensitive sensor is ideally suited  
for the automatic control of lighting  
in offices, corridors, sanitary facilities,  
changing rooms etc.

The two channel version also allows  
control of heating, ventilation and air  
conditioning





Certain areas in warehouses and archives are subject to heavy traffic. Some corridors are used less. Demand controlled automatic lighting control is ideal in this situation. As there is always constant movement in warehouses it is practical if the lighting is switched on and off automatically as required and cannot be left on.

LUXA 103-360 AP motion detectors are suitable for monitoring large internal areas for automatic lighting control. The two channel version also allows control of heating, ventilation and air conditioning.



LUXA 103-360 AP with one channel. The potentiometers under the sensor cover are protected against unauthorised adjustment.



Precise setting of brightness threshold (lux), lighting period (time) and required detection range (metres).



Quick and easy plug-in installation on the ceiling enables secure connection. Cable guide from the side or back of device.



LUXA 103-360/2 AP with two channels. Set via four potentiometers under the sensor cover.



Precise setting of brightness threshold (lux), lighting period (time), test, pulse control and detection range (metres). The second channel switching period for heating, ventilation or air conditioning can be set separately.



Quick and easy plug-in installation of two channel version. With a large number of fixing options to existing drill holes.

# LUXA 103 motion detector for surface mounting on ceiling



LUXA 103-360 AP



LUXA 103-360/2 AP

## LUXA 130-360 AP motion detector

- Passive infra-red motion detector for ceiling mounting
- Automatic lighting control based on presence and brightness
- Large detection area with a maximum 7 m diameter at installation height of 2.5 m
- Blended light measurement suitable for the control of fluorescent, incandescent and halogen lamps
- Instant start-up possible via factory preset
- Lighting control with adjustable light threshold value and adjustable run-on time
- Sensitivity can be reduced to limit detection area
- No unintentional adjustment due to covered up controls
- Single-handed plug-in installation with captive screws
- Additional pulse control can be selected for combination with staircase time switches (ELPA), building automation or SPS

## LUXA 130-360/2 AP motion detector

- as before but two channel version
- Second relay for HVAC control, presence dependent, floating
- HVAC control with programmable run-on time

## Connection diagrams:

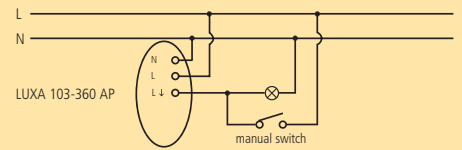

LUXA 103-360 AP with optional manual switch for constant light

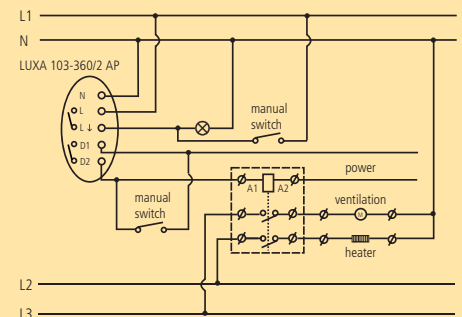

LUXA 103-360/2 AP with optional manual switch and heating or ventilation control depending on the time of the year

LUXA 103-360 AP detection range  
Installation height 2.5 m

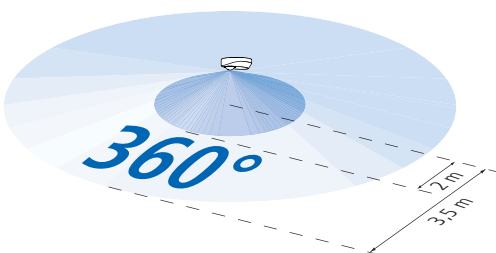

- Walking diagonally to the detector
- Walking head on to the detector



Technical data:	LUXA 103-360 AP	LUXA 103-360/2 AP
Operating voltage	230 V~ +10%/-15%	230 V~ +10%/-15%
Frequency	50-60 Hz	50-60 Hz
Brightness range	10-2000 lux (infinitely variable)	10-2000 lux (infinitely variable)
Power consumption	typically 5 VA	typically 8 VA
Channels	1	2
Contact	NO contact ( $\mu$ )	NO contact ( $\mu$ )
Switching capacity ( $\cos \varphi = 1$ resistive load)	10 A	10 A
Switching capacity ( $\cos \varphi = 0.3$ fluorescent lamp)	3 AX	3 AX
Incandescent lamp load	1000 W	1000 W
Halogen lamp load	1000 W	1000 W
Fluorescent lamps (VVG) corrected ①	400 VA (42 $\mu$ F)	400 VA (42 $\mu$ F)
Presence contact (HKL, D1-D2)		5 A ( $\cos \varphi = 1$ ), 250 V AC or 30 V DC
Detection range 2.5 m installation height standing	360° circular approx. $\varnothing$ 4-7 m (infinitely variable)	360° circular approx. $\varnothing$ 4-7 m (infinitely variable)
Installation height	2.0-3.0 m	2.0-3.0 m
Brightness range (lux)	10-2000 lux (infinitely adjustable)	10-2000 (infinitely variable)
Light channel switching period	Pulse (1 s)/TEST (2 s)/5 s-20 min	pulse (1 s)/TEST (2 s)/5 s-20 min
Presence channel switching period (HVAC)		10 s-60 min (infinitely variable)
Protection rating in accordance with EN 60529	IP 40	IP 40
Protection class in accordance with EN 60669-2-1	II, subject to correct installation	II, subject to correct installation
Operating temperature range	0 °C to + 45 °C	0 °C to + 45 °C
Installation type	Surface mounted on ceiling	Surface mounted on ceiling
Device order number	103 0 020	103 0 021

① Conventional ballast

Dimension diagrams (mm):

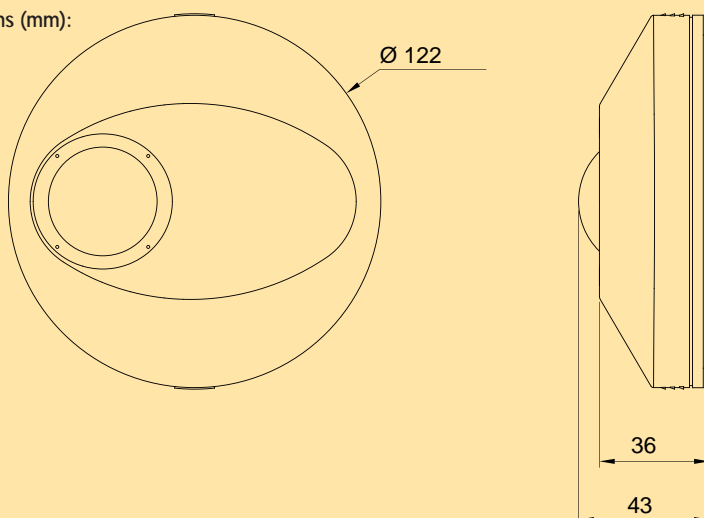

LUXA 103 motion detector  
for wall installation

# The ideal add-on for corridors, staircases, toilets or bathrooms.

## LUXA 103-200

LUXA 103-200 in relay  
or Triac version for flush-mounted  
wall installation

Attractive housing in white  
matching the 50 x 50 mm manu-  
facturer's switch frame

Integrated manual switch for  
continuous ON/OFF/AUTOMATIC

All setting controls are easily accessible  
under a cover panel

Highly sensitive sensor with insertable  
segments for limiting the detection range

Simple replacement for existing light  
switches

Easy add-on via 2-wire connection  
with the LUXA 103-200 T





Safety on stairs – the lights come on automatically even when your hands are full. The intelligent Theben LUXA sensor knows exactly when light is required. Easy to add-on as the motion detectors can be installed in place of wall mounted buttons or switches.

The LUXA 103-200 motion detector is ideal for exchanging with existing light switches in corridors, staircases, toilets, changing rooms etc. Suitable for incandescent and fluorescent lamps.



LUXA 103-200 setting under the cover panel via three potentiometers for brightness threshold (lux), lighting period (time) and detection range (metres) as well as connectable switch-off pre-warning.



LUXA 103-200 T (Triac) setting under the cover panel via three potentiometers for brightness threshold (lux), lighting period (time) and detection range (metres).



Segments can be inserted to limit the detection range in order to avoid to prevent the device being switched on unnecessarily.



Easy to use, large manual ON/OFF/AUTO switch. Switch light on by pushing the upper part of the sensor to the left.



Switch off by pushing upper part of sensor to the right. Central position for automatic mode.



Easy flush-mounted installation using fixed switch clamps.

# LUXA 103 motion detector for wall installation



LUXA 103-200



LUXA 103-200 T

## Function

- Compatible with branded switches, replaces conventional light switches
- Automatic lighting control based on presence and brightness
- Large 200° detection area with a maximum 8 m diameter at installation height of 1.2 m max.
- Detection area can be limited using insertable segments, avoids the device being switched on unnecessarily
- Lighting control with adjustable light threshold value and adjustable run-on time
- Sensitivity can be reduced to limit detection area
- Integrated pulse control for controlling staircase timers, SPS etc.
- Setting controls protected by clover flap
- Manual AUTO/ON/OFF switching by simple adjustment of cover flap
- Instant start-up possible via factory preset
- Screw terminals with additional double screw terminal for easy feed-through wiring (support terminal)
- Housing colour: pure white

## LUXA 103-200 motion detector

- Light switch output (relay 230 V~)
- With acoustic switch-off pre-warning 15 seconds before light switches off
- Expansion of detection area through integrated master/slave or master/master function when using up to 10 devices
- Blended light measurement suitable for the control of fluorescent, incandescent and halogen lamps

## LUXA 103-200 T motion detector

- 2-wire connection
- Light switch output (Triac 230 V~)
- Blended light measurement suitable for the control of incandescent and halogen lamps

LUXA 103-200 detection range  
LUXA 103-200 T  
Installation height 1.2 m – 2.0 m

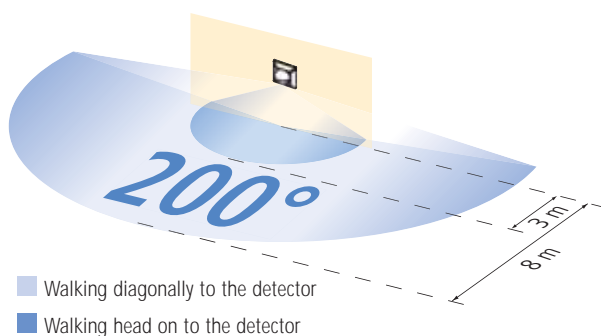

## Connection diagrams:

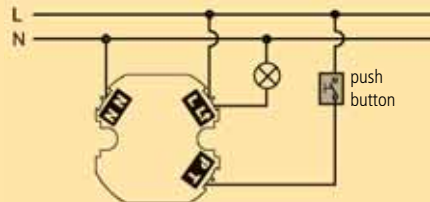

LUXA 103-200 with optional button

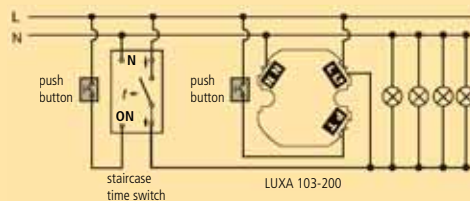

LUXA 103-200 in combination with a staircase time switch (ELPA)

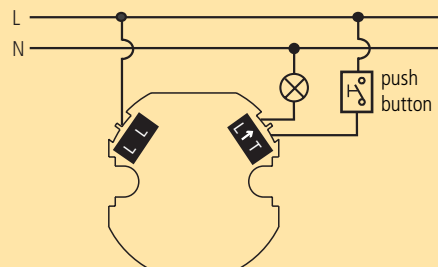

LUXA 103-200 T with 2 wire connection

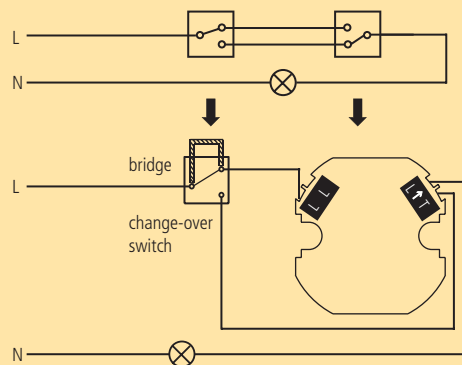

LUXA 103-200 T:  
Changing a switch with cross connection,  
2. switch serves as manual switch





Technical data:	LUXA 103-200	LUXA 103-200 T
Operating voltage	230 V~ +10%/-10%	230 V~ +10%/-10%
Frequency	50 Hz	50 Hz
Brightness range	10–1000 lux (infinitely variable)	10–1000 lux (infinitely variable)
Power consumption	typically 6 VA	typically 6 VA
Channels	1	1
Contact	NO contact ( $\mu$ )	Triac
Switching capacity (cos $\varphi$ = 1 resistive load)	10 A	2 A/230 V
Switching capacity (cos $\varphi$ = 0.3 fluorescent lamp)	3 AX	
Incandescent lamp load	1000 W	25–400 W
Halogen lamp load	1000 W	25–400 W
Fluorescent lamps (VVG) corrected ①	400 VA/42 $\mu$ F	
Detection range 1.2–2 m installation height	200° circular	200° circular
moving persons	approx. 1–8 m (infinitely variable)	approx. 1–8 m (infinitely variable)
Installation height	1.2–2.0 m	1.2–2.0 m
Brightness range (lux)	10–1000 lux (infinitely adjustable)	10–1000 (infinitely variable)
Light channel switching period	Pulse (1 s)/test (2 s)/20 s–30 min	Test (2 s)/20 s–30 min
Protection rating in accordance with EN 60529	IP 40	IP 40
Protection class in accordance with EN 60669-2-1	II, subject to correct installation	II, subject to correct installation
Operating temperature range	0 °C to + 45 °C	0 °C to + 45 °C
Installation type	Flush-mounted wall installation	Flush-mounted wall installation
Device order number	103 0 030	103 0 031

① Conventional ballast

Dimension diagrams (mm):

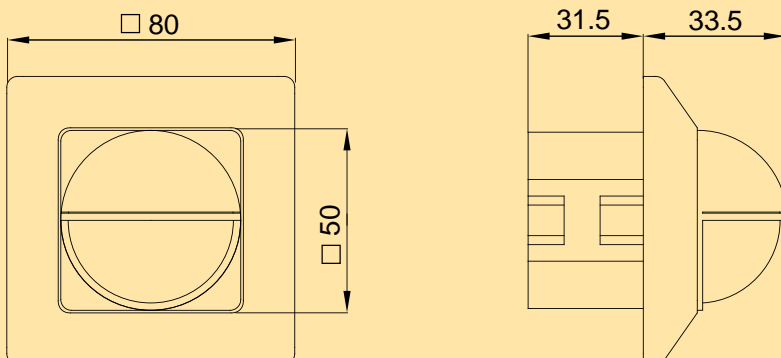

SPHINX 104 presence detector  
for ceiling installation

# Eagle eyes bring everything into view.

SPHINX 104-360

Attractive, square housing  
in white without  
visible fixing screws

Highly sensitive sensor that detects  
even the smallest movements in the  
workplace so that you are not suddenly  
left in the dark

Easy configuration through  
additional remote control

Easy to read potentiometer

A cover plate protects all the settings  
from tampering

Detection area can be limited to avoid  
unnecessary switching of device  
(3 segments included in scope of supply)





As classrooms are only used at certain times, great energy savings can be achieved via automatic, presence-dependent lighting and air conditioning. Neither students nor teachers are responsible for turning out the lights if they are the last to leave the room. A window and wall light group with a presence detector each allows the varying brightness levels of the room to be taken into account.

The sensitive sensor is ideally suited to the automatic control of lighting in offices, corridors, sanitary facilities, changing rooms etc. The two channel version is capable of controlling heating, ventilation and air conditioning.



SPHINX 104 in flat housing for installation in flush-mounted back boxes.



Time saving when connecting via screwless terminals.



Simple lux value and time setting with protective cover against unauthorised adjustment. HVAC channel switches on presence dependent basis with on/off switch delay, producing particularly efficient operation.



The SPHINX 104 AP is particularly suitable for retrofitting on ceilings or walls. Screws and rawlplugs are included in the scope of supply.



The single handed plug-in base provides a secure connection through screw terminals. Cable guide from below or at the back of the base.



Easy setting or subsequent correction of parameters through optional remote controls. Simple manual operation through user remote control with additional teach-in function.

# SPHINX 104 presence detector

## Ceiling mounted



SPHINX 104-360  
SPHINX 104-360/2



SPHINX 104-360 AP  
SPHINX 104-360/2 AP

### ■ SPHINX 104-360 presence detector

- Passive infra-red presence detector for ceiling installation in flush-mounted socket
- Automatic lighting control based on presence and brightness
- Detection range 360°
- Detection range can be limited using three enclosed segments. This avoids switching the device on unnecessarily
- Blended light measurement suitable for the control of fluorescent, incandescent and halogen lamps
- Instant start-up possible via factory preset
- Lighting control with adjustable light threshold value and adjustable run-on time
- Additional pulse control can be selected for combination with staircase time switches (ELPA), building automation or SPS
- Button or switch options for manual switching
- Master/slave parallel switching: Up to ten detectors can be connected with each other to expand detection area. The master switches the load. All other detectors merely provide presence information as slaves.
- A cover plate protects setting controls against manipulation
- Screwless terminals for quick installation
- RC 104 Pro service remote control (optional)
- RC 104 Pro user remote control (optional)
- Memorising of current brightness value possible via remote control

### ■ SPHINX 104-360/2 presence detector

- as before but two channel version
- Second relay for HVAC control, presence dependent
- HVAC control with programmable switch on delay and run-on time
- Sturdy installation plate with screwless terminals for quick and easy installation

### ■ SPHINX 104-360 AP presence detector

- 1 channel presence detector as SPHINX 104, but for surface-mounting on ceiling

### ■ SPHINX 104-360/2 AP presence detector

- as before but two channel version
- Second relay for HVAC control, presence dependent
- HVAC control with programmable switch on delay and run-on time

### Connection diagrams:

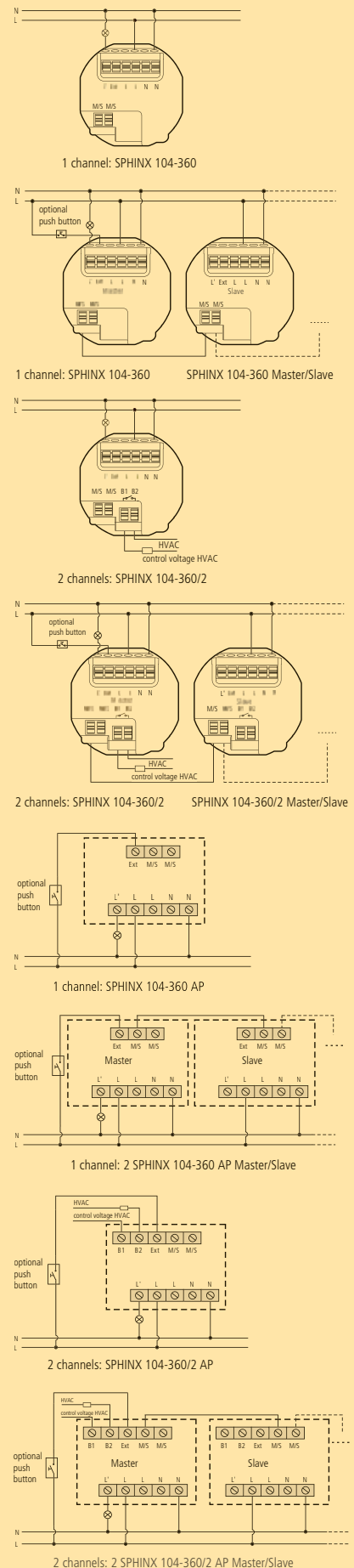

SPHINX 104-360 detection range  
Installation height 2.5 m

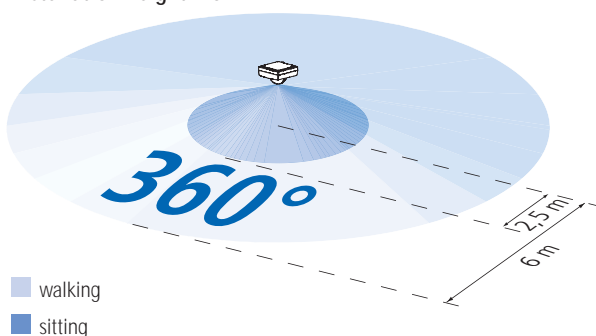



Technical data:	SPHINX 104-360	SPHINX 104-360/2	SPHINX 104-360 AP	SPHINX 104-360/2 AP
Operating voltage	230 V- +10%/-15 %	230 V- +10%/-15 %	230 V- +10%/-15 %	230 V- +10%/-15 %
Frequency	50–60 Hz	50–60 Hz	50–60 Hz	50–60 Hz
Brightness range	10–2000 Lux	10–2000 Lux	10–2000 Lux	10–2000 Lux
Power consumption	typically 8 VA	typically 9 VA	typically 8 VA	typically 9 VA
Channels	1	2	1	2
Light contact	NO contact (μ)	NO contact (μ)	NO contact (μ)	NO contact (μ)
Switching capacity (cos φ = 1 resistive load)	8 A	8 A	16 A	16 A
Switching capacity (cos φ = 0.3 fluorescent lamp)	8 AX	8 AX	8 AX	8 AX
Incandescent lamp load	1800 W	1800 W	2000 W	2000 W
Halogen lamp load	1800 W	1800 W	2000 W	2000 W
Fluorescent lamp VVG (uncorrected) ①	900 VA	900 VA	900 VA	900 VA
Fluorescent lamp VVG (series-corrected) ①	900 VA	900 VA	900 VA	900 VA
Fluorescent lamp VVG (parallel-corrected) ①	400 VA (42 μF)	400 VA (42 μF)	400 VA (42 μF)	400 VA (42 μF)
Fluorescent lamp VVG (lead-lag circuit ) ①	900 VA	900 VA	900 VA	900 VA
Fluorescent lamps – EVG ②	400 VA	400 VA	400 VA	400 VA
Compact fluorescent lamps – EVG ②	4 x 7 W, 3 x 11 W, 3 x 15 W, 3 x 20 W, 3 x 23 W	4 x 7 W, 3 x 11 W, 3 x 15 W, 3 x 20 W, 3 x 23 W	4 x 7 W, 3 x 11 W, 3 x 15 W, 3 x 20 W, 3 x 23 W	4 x 7 W, 3 x 11 W, 3 x 15 W, 3 x 20 W, 3 x 23 W
Presence contact floating (HVAC)		3 A max. (cos φ = 1), 250 V AC or 30 V DC		3 A max. (cos φ = 1), 250 V AC or 30 V DC
Detection area 2.5–3.5 m installation height moving	360° circular approx. Ø 12–14 m	360° circular approx. Ø 12–14 m	360° circular approx. Ø 12–14 m	360° circular approx. Ø 12–14 m
seated	5 m	5 m	5 m	5 m
Installation height	2.5–3.5 m	2.5–3.5 m	2.5–3.5 m	2.5–3.5 m
Light channel switching period	1 s–20 min	1 s–20 min	1 s–20 min	1 s–20 min
Presence channel switch-on delay (HVAC)		0–60 min		0–60 min
Presence channel switch-on duration (HVAC)		1–120 min		1–120 min
Protection rating in accordance with EN 60529	IP 41	IP 41	IP 41	IP 41
Protection class in accordance with EN 60669-2-1	II, subject to designated installation	II, subject to designated installation	II, subject to designated installation	II, subject to designated installation
Operating temperature range	-10 °C to +55 °C	-10 °C to +55 °C	-10 °C to +55 °C	-10 °C to +55 °C
Optional remote control	User, Service	User, Service	User, Service	User, Service
Installation type	Ceiling installation, flush-mounted	Ceiling installation, flush-mounted	Surface mounted on ceiling	Surface mounted on ceiling
Presence detector order number	<b>104 0 370</b>	<b>104 0 372</b>	<b>104 0 360</b>	<b>104 0 362</b>
Service remote control order number	907 0 536	907 0 536	907 0 536	907 0 536
User remote control order number	907 0 538	907 0 538	907 0 538	907 0 538

① Conventional ballast, ② Electronic ballast

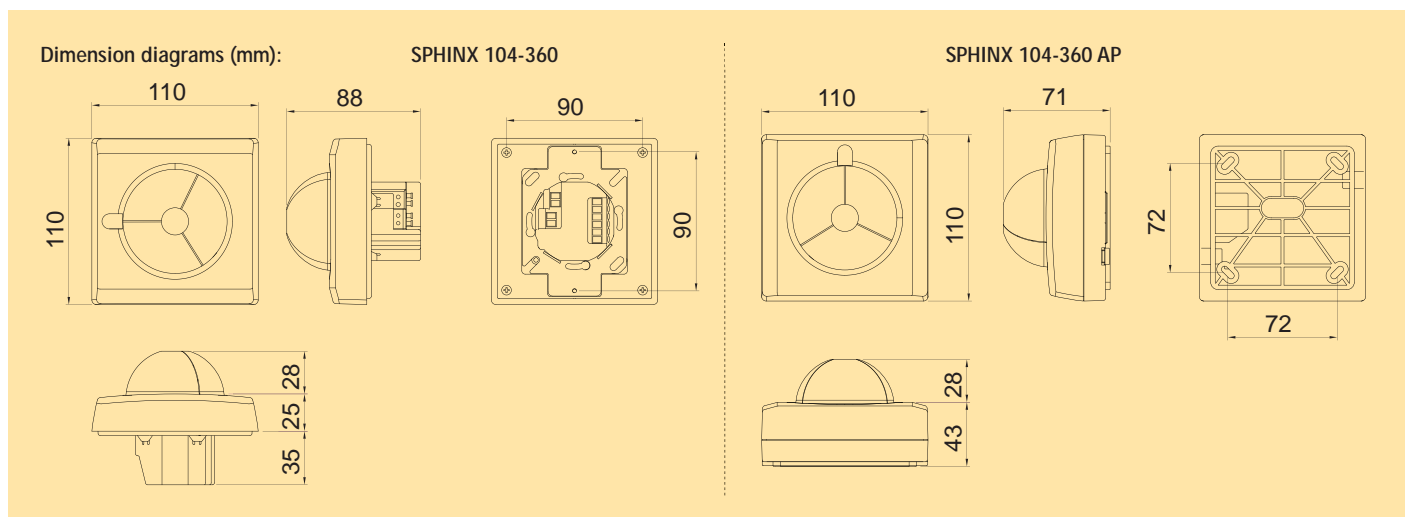

SPHINX 105 motion detector  
for wall, ceiling or corner installation

# The universally mountable external motion detector

SPHINX 105

A cover plate protects all the settings from manipulation

Attractive housing in white for wall, ceiling or corner installation

Highly sensitive sensor with rotating detection area

IP55 thus suitable for wet rooms, garages and cellar entrances

Easy configuration through additional remote control

15 position sensor enables installation under overhanging roofs

Ceiling installation through flat folded sensor







### Burglaries in Germany in 7 months:

**160,707** There is a burglary every two minutes.

### Number solved:

**31,016** Only every fifth burglary is solved.

### Losses in euros:

**335,413,242** This amount increases by 2,442 euros every two minutes.

The elegant external motion detector that lights up your chats with your neighbour.

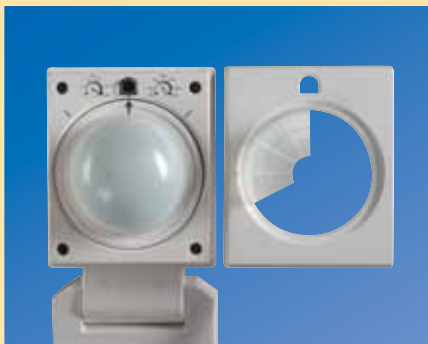

Complete covering protects unauthorised access to settings. Up to three segments can be inserted to limit the detection range in order to avoid preventing the device being switched on unnecessarily.

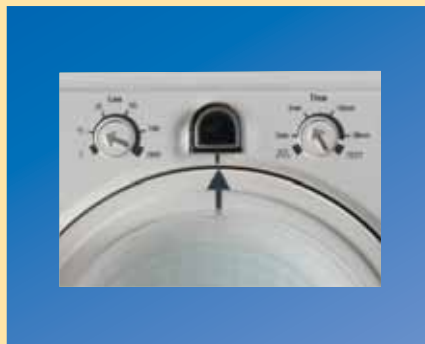

Simple lux value and time setting with protective cover against unauthorised adjustment. 180° detection area for optimum use of the area. Light sensor with blended light measurement suitable for the control of fluorescent, incandescent and halogen lamps.



Easily accessible, removable terminals in the plug-in base facilitate installation on walls. Cable guide with two rubber grommets from below or at the back of the device. Screwless terminals for quick installation.



SPHINX 105 – 300 incl. corner adapter is ideal for monitoring two facades with one device. Screws and rawplugs are included in the scope of supply.



SPHINX 105 – 110 with additional corner adapter is ideal for monitoring outdoor corner seats. The applicable creep under protection provides additional security.



Easy setting or subsequent correction of parameters without tools or ladders via optional remote control.

# SPHINX 105 motion detector for wall, ceiling or corner installation



SPHINX 105

## SPHINX 105 motion detector

- Passive infrared motion detector for wall and ceiling mounting, internal or external corner installation
- Automatic lighting control based on presence and brightness
- Sensor head can be adjusted horizontally by  $\pm 90^\circ$ , vertically by  $90^\circ$  upwards or  $25^\circ$  downwards creating universal installation option and optimum setting of detection area
- Additional creep under protection for  $360^\circ$  detection with 5 m diameter at installation height of 2.5 m. Can be operated via remote control
- Detection range can be limited using enclosed segments. This avoids switching the device on unnecessarily
- Blended light measurement suitable for the control of fluorescent (FL/FPL), incandescent and halogen lamps
- Instant start-up possible via factory preset
- Lighting control with adjustable light threshold value and adjustable run-on time
- Additional pulse control can be selected for combination with staircase time switches (ELPA)
- A cover plate protects setting controls against manipulation
- Screwless terminals for quick installation
- Single-handed plug-in installation with captive screws
- RC 105 Pro service remote control (optional)
- RC 105 Pro user remote control (optional)
- Memorising of current brightness value possible via remote control

## Connection diagrams:

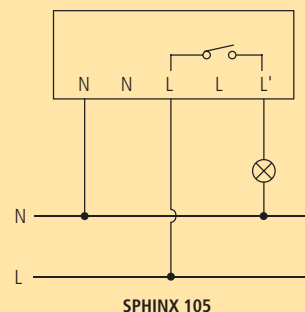

SPHINX corner installation bracket

## SPHINX 105-110 motion detector

- as above but with  $110^\circ$  detection range
- Particularly suitable for:
  - narrow courtyard entrances, property entrances or paths
  - Internal corner installation with optional corner installation bracket

## SPHINX 105-220 motion detector

- as above but with  $220^\circ$  detection range
- Particularly suitable for:
  - sides of properties, entrances and drives

## SPHINX 105-300 motion detector

- as above but with  $300^\circ$  detection range
- Corner installation bracket for internal or external corners included in delivery
- Particularly suitable for:
  - external corner installation for simultaneous detection of two facades via detection of set back facades or recesses

SPHINX 105-110 detection range  
Installation height: 2.5 m



SPHINX 105-220 detection range

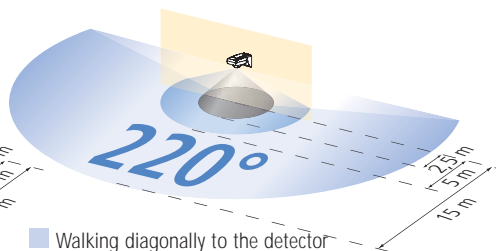

SPHINX 105-300 detection range

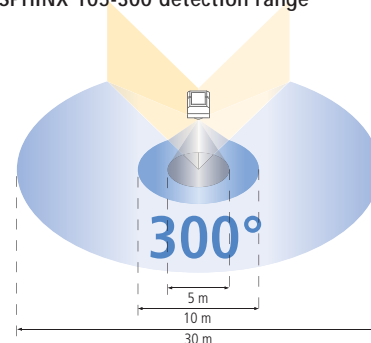

- Walking diagonally to the detector
- Walking head on to the detector
- Creep under protection



Technical data:	SPHINX 105-110	SPHINX 105-220	SPHINX 105-300
Operating voltage	230 V~ +10 %/-15 %	230 V~ +10 %/-15 %	230 V~ +10 %/-15 %
Frequency	50-60 Hz	50-60 Hz	50-60 Hz
Brightness range	2-2000 Lux	2-2000 Lux	2-2000 Lux
Power consumption	typically 8 VA	typically 8 VA	typically 8 VA
Channels	1	1	1
Contact	NO contact ( $\mu$ )	NO contact ( $\mu$ )	NO contact ( $\mu$ )
Switching capacity ( $\cos \varphi = 1$ resistive load)	16 A	16 A	16 A
Switching load ( $\cos \varphi = 0.6$ motor load)	10 A	10 A	10 A
Switching capacity ( $\cos \varphi = 0.3$ fluorescent lamp)	8 AX	8 AX	8 AX
Incandescent lamp load	2300 W	2300 W	2300 W
Halogen lamp load	2300 W	2300 W	2300 W
Fluorescent lamp VVG (uncorrected) ①	900 VA	900 VA	900 VA
Fluorescent lamp VVG (series-corrected) ①	900 VA	900 VA	900 VA
Fluorescent lamp VVG (parallel-corrected) ①	400 VA (42 $\mu$ F)	400 VA (42 $\mu$ F)	400 VA (42 $\mu$ F)
Fluorescent lamp VVG (lead-lag circuit ) ①	900 VA	900 VA	900 VA
Fluorescent lamps – EVG ②	400 VA	400 VA	400 VA
Compact fluorescent lamps – EVG	9x7 W, 7x11 W, 7x15 W, 7x20 W, 7x23 W	9x7 W, 7x11 W, 7x15 W, 7x20 W, 7x23 W	9x7 W, 7x11 W, 7x15 W, 7x20 W, 7x23 W
Detection angle	up to 110 °	up to 220°	up to 300°
Detection range at height of 2.5 m	2.5-15 m	2.5-15 m	2.5-15 m
Creep under protection	Ø 5 m	Ø 5 m	Ø 5 m
Sensor head setting	90° lateral, 90° upwards, 25° downwards	90° lateral, 90° upwards, 25° downwards	90° lateral, 90° upwards, 25° downwards
Switching period range	1 s-20 min	1 s-20 min	1 s-20 min
Protection rating in accordance with EN 60529	IP 55	IP 55	IP 55
Protection class in accordance with EN 60669-2-1	II, subject to correct installation	II, subject to correct installation	II, subject to correct installation
Operating temperature range	-25 ° to +55 °C	-25 ° to +55 °C	-25 ° to +55 °C
Optional remote control	User, Service	User, Service	User, Service
Installation type	Wall and ceiling mounted, Optional corner installation	wall and ceiling mounted, Optional corner installation	wall and ceiling mounted, incl. corner installation bracket
Motion detector order number	105 0 110	105 0 220	105 0 300
Corner installation bracket order number	907 0 535	907 0 535	907 0 535
Service remote control order number	907 0 537	907 0 537	907 0 537
User remote control order number	907 0 539	907 0 539	907 0 539

① Conventional ballast, ② Electronic ballast

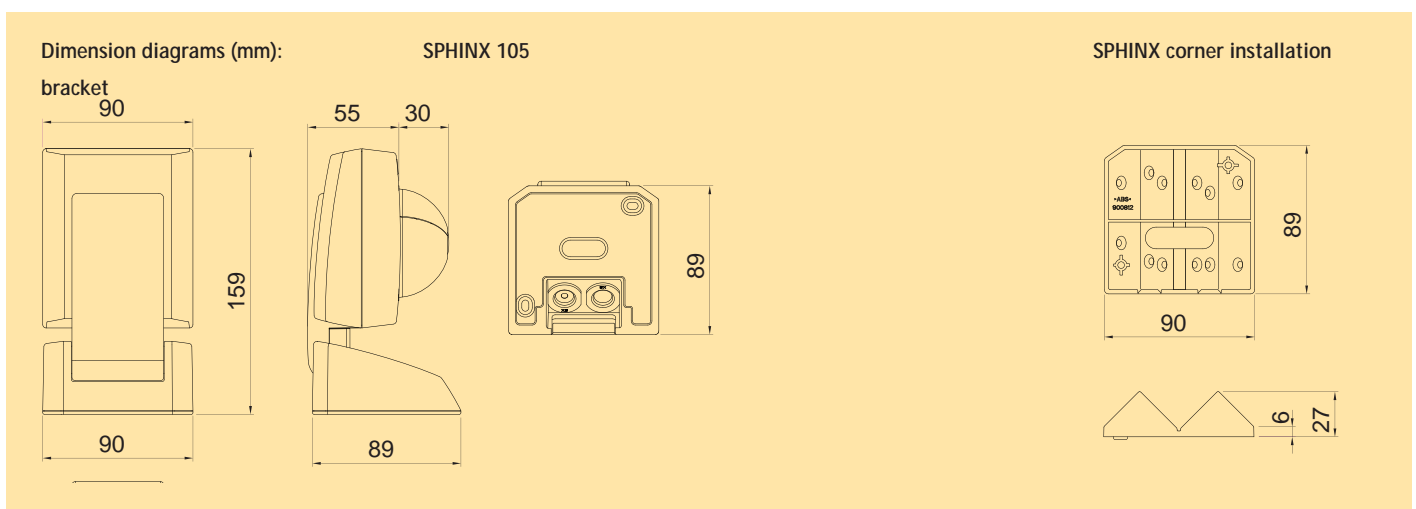



# theben®

Theben AG  
Hohenbergstraße 32, 72401 Haigerloch, GERMANY  
Postfach 56, 72394 Haigerloch, GERMANY  
Phone +49 (0)74 74/6 92-0  
Fax +49 (0)74 74/6 92-150  
E-mail: [info@theben.de](mailto:info@theben.de), [www.theben.de](http://www.theben.de)